

MC74VHC259

8-Bit Addressable Latch/1-of-8 Decoder CMOS Logic Level Shifter with LSTTL-Compatible Inputs

The MC74VHC259 is an 8-bit Addressable Latch fabricated with silicon gate CMOS technology. It achieves high speed operation similar to equivalent Bipolar Schottky TTL devices while maintaining CMOS low power dissipation.

The VHC259 is designed for general purpose storage applications in digital systems. The device has four modes of operation as shown in the mode selection table.. In the addressable latch mode, the data on Data In is written into the addressed latch. The addressed latch follows the data input with all non-addressed latches remaining in their previous states. In the memory mode, all latches remain in their previous state and are unaffected by the Data or Address inputs. In the one-of-eight decoding or demultiplexing mode, the addressed output follows the state of Data In with all other outputs in the LOW state. In the Reset mode, all outputs are LOW and unaffected by the address and data inputs. When operating the VHC259 as an addressable latch, changing more than one bit of the address could impose a transient wrong address. Therefore, this should only be done while in the memory mode.

The MC74VHC259 input structure provides protection when voltages up to 7 V are applied, regardless of the supply voltage. This allows the MC74VHC259 to be used to interface 5 V circuits to 3 V circuits.

- High Speed: $t_{PD} = 7.6 \text{ ns}$ (Typ) at $V_{CC} = 5 \text{ V}$
- Low Power Dissipation: $I_{CC} = 2 \mu\text{A}$ (Max) at $T_A = 25^\circ\text{C}$
- High Noise Immunity: $V_{NIH} = V_{NIL} = 28\% V_{CC}$
- CMOS-Compatible Outputs: $V_{OH} > 0.8 V_{CC}$; $V_{OL} < 0.1 V_{CC}$ @Load
- Power Down Protection Provided on Inputs and Outputs
- Balanced Propagation Delays
- Pin and Function Compatible with Other Standard Logic Families
- Latchup Performance Exceeds 300 mA
- ESD Performance: HBM > 2000 V
- **These devices are available in Pb-free package(s). Specifications herein apply to both standard and Pb-free devices. Please see our website at www.onsemi.com for specific Pb-free orderable part numbers, or contact your local ON Semiconductor sales office or representative.**

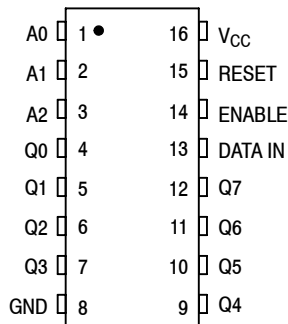

Figure 1. Pin Assignment



ON Semiconductor™

<http://onsemi.com>

MARKING DIAGRAMS

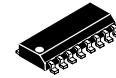

SOIC-16
D SUFFIX
CASE 751B

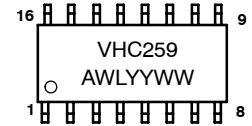

TSSOP-16
DT SUFFIX
CASE 948F

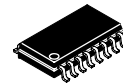
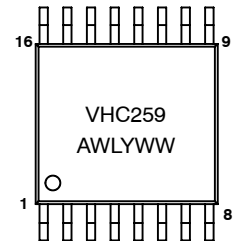

SOIC EIAJ-16
M SUFFIX
CASE 966

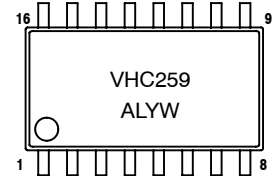

A = Assembly Location
L, WL = Wafer Lot
Y, YY = Year
W, WW = Work Week

ORDERING INFORMATION

Device	Package	Shipping
MC74VHC259D	SOIC-16	48 Units/Rail
MC74VHC259DR2	SOIC-16	2500 Units/Reel
MC74VHC259DT	TSSOP-16	96 Units/Rail
MC74VHC259DTR2	TSSOP-16	2500 Units/Reel
MC74VHC259M	SOIC EIAJ-16	50 Units/Rail
MC74VHC259MEL	SOIC EIAJ-16	2000 Units/Reel

MC74VHC259

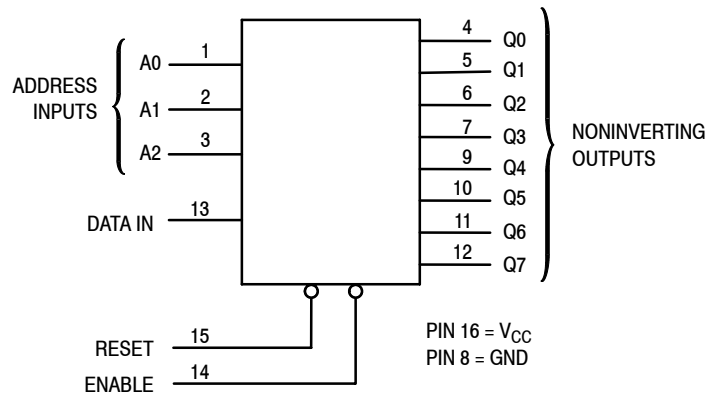

Figure 2. Logic Diagram

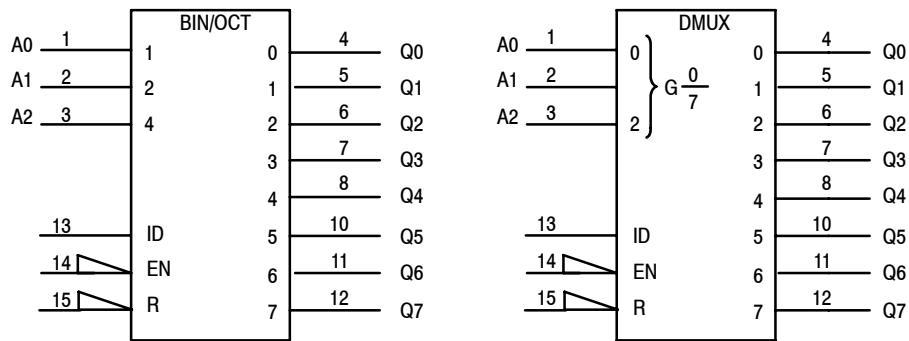

Figure 3. IEC Logic Symbol

LATCH SELECTION TABLE

Address Inputs			Latch Addressed
C	B	A	
L	L	L	Q0
L	L	H	Q1
L	H	L	Q2
L	H	H	Q3
H	L	L	Q4
H	L	H	Q5
H	H	L	Q6
H	H	H	Q7

MODE SELECTION TABLE

Enable	Reset	Mode
L	H	Addressable Latch
H	H	Memory
L	L	8-Line Demultiplexer
H	L	Reset

MC74VHC259

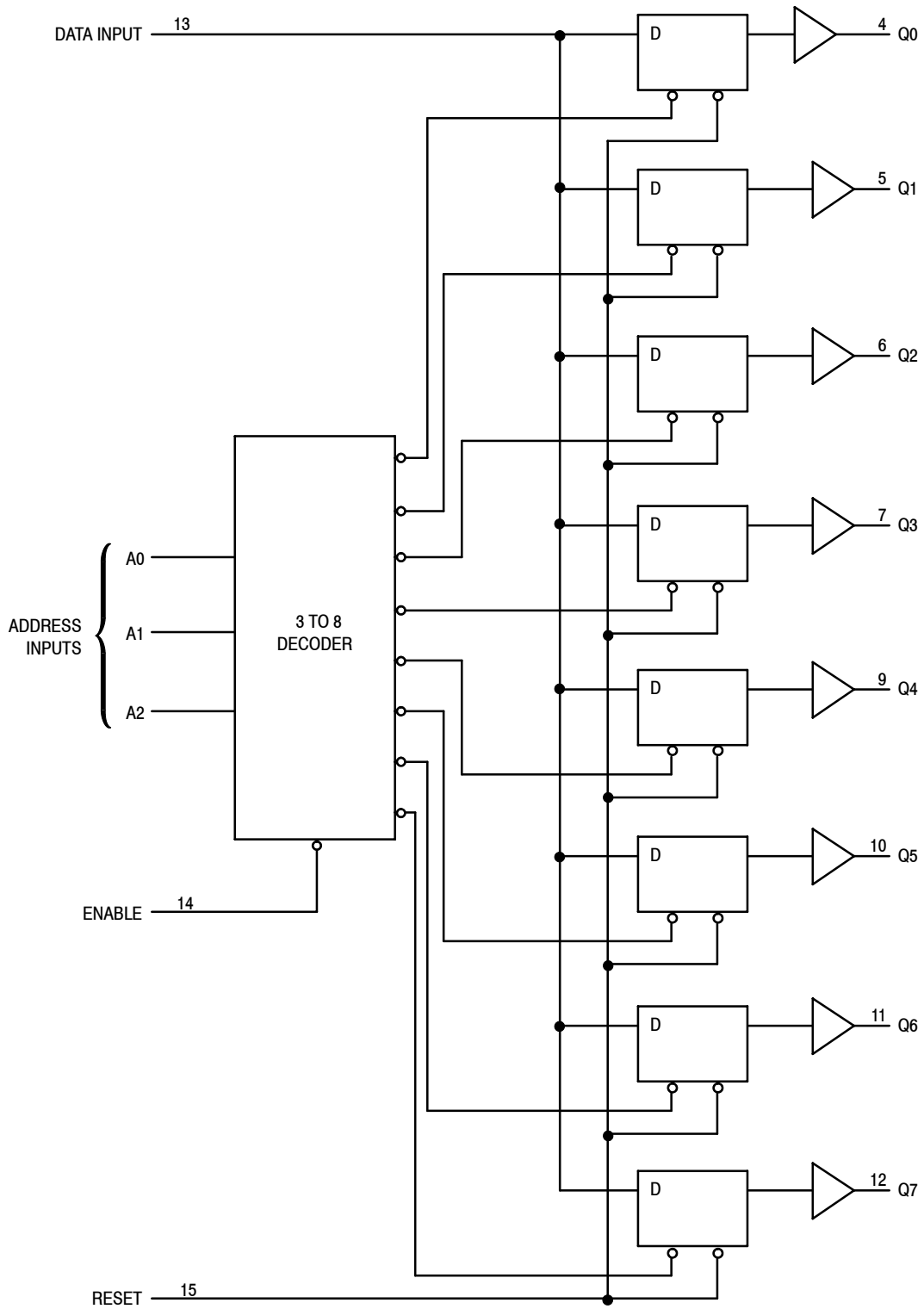

Figure 4. Expanded Logic Diagram

MC74VHC259

MAXIMUM RATINGS (Note 1.)

Symbol	Parameter	Value	Unit	
V _{CC}	Positive DC Supply Voltage	-0.5 to +7.0	V	
V _{IN}	Digital Input Voltage	-0.5 to +7.0	V	
V _{OUT}	DC Output Voltage	-0.5 to V _{CC} +0.5	V	
I _{IK}	Input Diode Current	-20	mA	
I _{OK}	Output Diode Current	± 20	mA	
I _{OUT}	DC Output Current, per Pin	± 25	mA	
I _{CC}	DC Supply Current, V _{CC} and GND Pins	± 75	mA	
P _D	Power Dissipation in Still Air	SOIC Package TSSOP	200 180	mW
T _{STG}	Storage Temperature Range	-65 to +150	°C	
V _{ESD}	ESD Withstand Voltage	Human Body Model (Note 2.) Machine Model (Note 3.) Charged Device Model (Note 4.)	>2000 >200 >2000	V
I _{LATCH-UP}	Latch-Up Performance	Above V _{CC} and Below GND at 125°C (Note 5.)	± 300	mA
θ _{JA}	Thermal Resistance, Junction to Ambient	SOIC Package TSSOP	143 164	°C/W

1. Maximum Ratings are those values beyond which damage to the device may occur. Functional operation should be restricted to the Recommended Operating Conditions.
2. Tested to EIA/JESD22-A114-A
3. Tested to EIA/JESD22-A115-A
4. Tested to JESD22-C101-A
5. Tested to EIA/JESD78

RECOMMENDED OPERATING CONDITIONS

Symbol	Characteristics	Min	Max	Unit	
V _{CC}	DC Supply Voltage	2.0	5.5	V	
V _{IN}	DC Input Voltage	0	5.5	V	
V _{OUT}	DC Output Voltage	0	V _{CC}	V	
T _A	Operating Temperature Range, all Package Types	-55	125	°C	
t _r , t _f	Input Rise or Fall Time	V _{CC} = 3.3 V ± 0.3 V V _{CC} = 5.0 V ± 0.5 V	0	20	ns/V

DEVICE JUNCTION TEMPERATURE VERSUS TIME TO 0.1% BOND FAILURES

Junction Temperature °C	Time, Hours	Time, Years
80	1,032,200	117.8
90	419,300	47.9
100	178,700	20.4
110	79,600	9.4
120	37,000	4.2
130	17,800	2.0
140	8,900	1.0

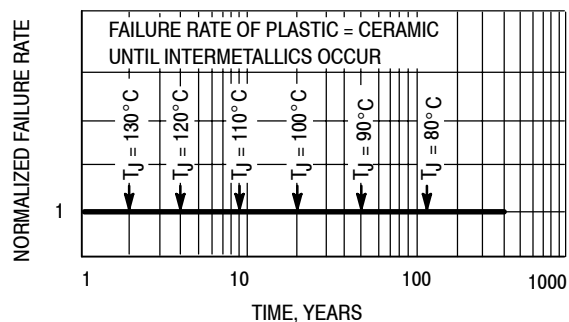

Figure 5. Failure Rate vs. Time Junction Temperature

MC74VHC259

DC CHARACTERISTICS (Voltages Referenced to GND)

Symbol	Parameter	Condition	V _{CC} (V)	T _A = 25°C			-55°C ≤ T _A ≤ 125°C		Unit
				Min	Typ	Max	Min	Max	
V _{IH}	Minimum High-Level Input Voltage		2.0 3.0 to 5.5	1.5 V _{CCX} 0.7			1.5 V _{CCX} 0.7		V
V _{IL}	Maximum Low-Level Input Voltage		2.0 3.0 to 5.5			0.5 V _{CCX} 0.3		0.5 V _{CCX} 0.3	V
V _{OH}	Maximum High-Level Output Voltage	V _{IN} = V _{IH} or V _{IL} I _{OH} = -50 μA	2.0 3.0 4.5	1.9 2.9 4.4	2.0 3.0 4.5		1.9 2.9 4.4		V
		V _{IN} = V _{IH} or V _{IL} I _{OL} = 4 mA I _{OL} = 8 mA	3.0 4.5	2.58 3.94			2.48 3.8		V
V _{OL}	Maximum Low-Level Output Voltage	V _{IN} = V _{IH} or V _{IL} I _{OL} = 50 μA	2.0 3.0 4.5		0.0 0.0 0.0	0.1 0.1 0.1		0.1 0.1 0.1	V
		V _{IN} = V _{IH} or V _{IL} I _{OL} = 4 mA I _{OL} = 8 mA	3.0 4.5		0.36 0.36			0.44 0.44	V
I _{IN}	Input Leakage Current	V _{IN} = 5.5 V or GND	0 to 5.5			±0.1		±1.0	μA
I _{CC}	Maximum Quiescent Supply Current	V _{IN} = V _{CC} or GND	5.5			4.0		40.0	μA

AC ELECTRICAL CHARACTERISTICS (Input t_r = t_f = 3.0ns)

Symbol	Parameter	Test Conditions	T _A = 25°C			T _A ≤ 85°C		-55°C ≤ T _A ≤ 125°C		Unit
			Min	Typ	Max	Min	Max	Min	Max	
t _{PLH} , t _{PHL}	Maximum Propagation Delay, Data to Output (Figures 6 and 11)	V _{CC} = 3.3 ± 0.3V C _L = 15pF C _L = 50pF		6.0 8.5	8.5 12.5	1.0 1.0	11.5 14.5	1.0 1.0	11.5 14.5	ns
		V _{CC} = 5.0 ± 0.5V C _L = 15pF C _L = 50pF		4.9 7.0	8.0 10.0	1.0 1.0	9.5 11.5	1.0 1.0	9.5 11.5	
t _{PLH} , t _{PHL}	Maximum Propagation Delay, Address Select to Output (Figures 7 and 11)	V _{CC} = 3.3 ± 0.3V C _L = 15pF C _L = 50pF		6.0 8.5	8.5 12.5	1.0 1.0	11.5 14.5	1.0 1.0	11.5 14.5	ns
		V _{CC} = 5.0 ± 0.5V C _L = 15pF C _L = 50pF		4.9 7.0	8.0 10.0	1.0 1.0	9.5 11.5	1.0 1.0	9.5 11.5	
t _{PLH} , t _{PHL}	Maximum Propagation Delay, Enable to Output (Figures 8 and 11)	V _{CC} = 3.3 ± 0.3V C _L = 15pF C _L = 50pF		6.0 8.5	8.5 12.5	1.0 1.0	11.5 14.5	1.0 1.0	11.5 14.5	ns
		V _{CC} = 5.0 ± 0.5V C _L = 15pF C _L = 50pF		4.9 7.0	8.0 10.0	1.0 1.0	9.5 11.5	1.0 1.0	9.5 11.5	
t _{PHL}	Maximum Propagation Delay, Reset to Output (Figures 9 and 11)	V _{CC} = 3.3 ± 0.3V C _L = 15pF C _L = 50pF		6.0 8.5	8.5 12.5	1.0 1.0	11.5 14.5	1.0 1.0	11.5 14.5	ns
		V _{CC} = 5.0 ± 0.5V C _L = 15pF C _L = 50pF		4.9 7.0	8.0 10.0	1.0 1.0	9.5 11.5	1.0 1.0	9.5 11.5	
C _{IN}	Maximum Input Capacitance			6 10			10		10	pF

C _{PD}	Power Dissipation Capacitance (Note 1)	Typical @ 25°C, V _{CC} = 5.0V		pF
		30		

1. C_{PD} is defined as the value of the internal equivalent capacitance which is calculated from the operating current consumption without load. Average operating current can be obtained by the equation: I_{CC(OPR)} = C_{PD} • V_{CC} • f_{in} + I_{CC}. C_{PD} is used to determine the no-load dynamic power consumption; P_D = C_{PD} • V_{CC}² • f_{in} + I_{CC} • V_{CC}.

MC74VHC259

TIMING REQUIREMENTS (Input $t_r = t_f = 3.0\text{ns}$)

Symbol	Parameter	Test Conditions	$T_A = 25^\circ\text{C}$			$T_A = \leq 85^\circ\text{C}$		$T_A = \leq 125^\circ\text{C}$		Unit
			Min	Typ	Max	Min	Max	Min	Max	
t_w	Minimum Pulse Width, Reset or Enable (Figure 10)	$V_{CC} = 3.3 \pm 0.3\text{V}$	5.0			5.5		5.5		ns
		$V_{CC} = 5.0 \pm 0.5\text{V}$	5.0			5.5		5.5		
t_{su}	Minimum Setup Time, Address or Data to Enable (Figure 10)	$V_{CC} = 3.3 \pm 0.3\text{V}$	4.5			4.5		4.5		ns
		$V_{CC} = 5.0 \pm 0.5\text{V}$	3.0			3.0		3.0		
t_h	Minimum Hold Time, Enable to Address or Data (Figure 8 or 9)	$V_{CC} = 3.3 \pm 0.3\text{V}$	2.0			2.0		2.0		ns
		$V_{CC} = 5.0 \pm 0.5\text{V}$	2.0			2.0		2.0		
t_r, t_f	Maximum Input, Rise and Fall Times (Figure 6)	$V_{CC} = 3.3 \pm 0.3\text{V}$			400		300		300	ns
		$V_{CC} = 5.0 \pm 0.5\text{V}$			200		100		100	

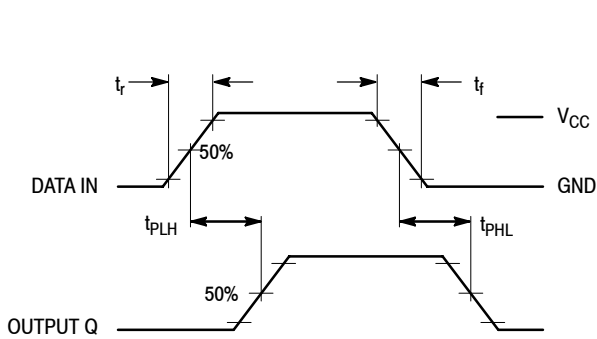

Figure 6. Switching Waveform

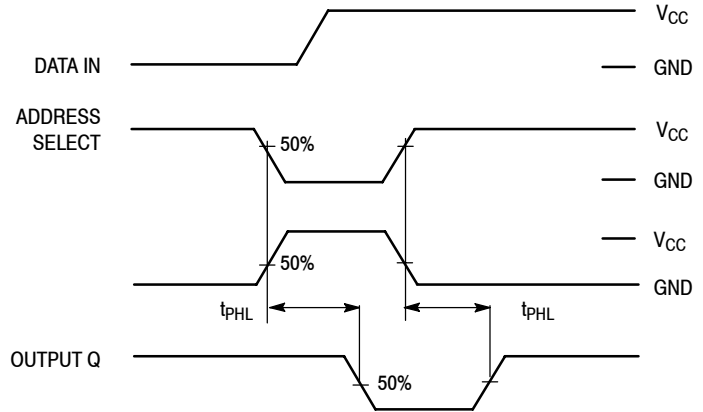

Figure 7. Switching Waveform

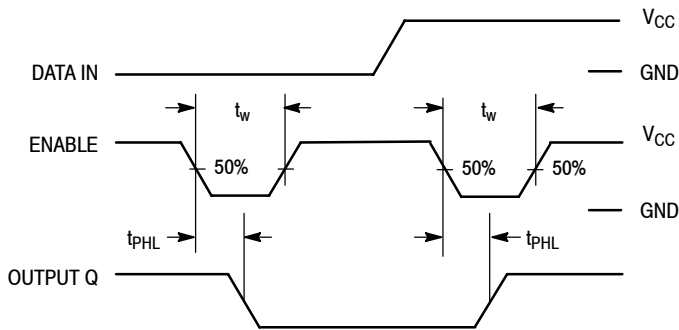

Figure 8. Switching Waveform

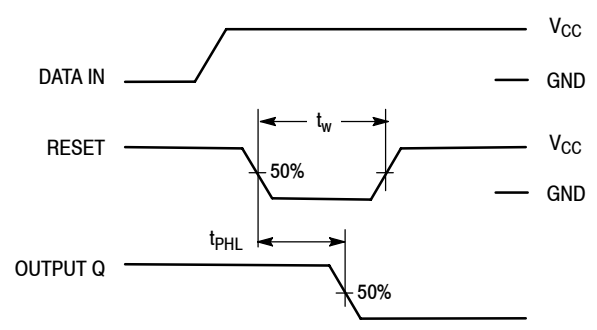

Figure 9. Switching Waveform

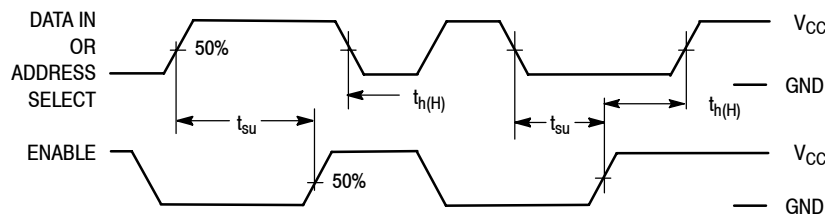
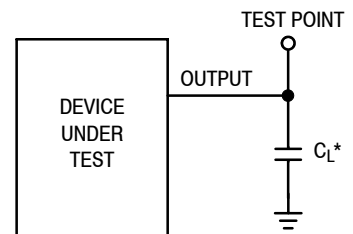

Figure 10. Switching Waveform



*Includes all probe and jig capacitance

Figure 11. Test Circuit

MC74VHC259

PACKAGE DIMENSIONS

SOIC-16
D SUFFIX
CASE 751B-05
ISSUE J

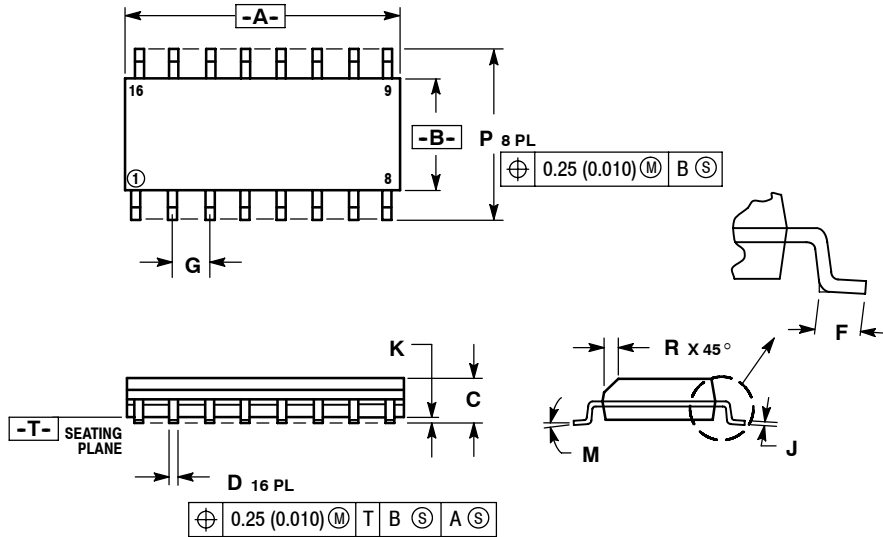

NOTES:

1. DIMENSIONING AND TOLERANCING PER ANSI Y14.5M, 1982.
2. CONTROLLING DIMENSION: MILLIMETER.
3. DIMENSIONS A AND B DO NOT INCLUDE MOLD PROTRUSION.
4. MAXIMUM MOLD PROTRUSION 0.15 (0.006) PER SIDE.
5. DIMENSION D DOES NOT INCLUDE DAMBAR PROTRUSION. ALLOWABLE DAMBAR PROTRUSION SHALL BE 0.127 (0.005) TOTAL IN EXCESS OF THE D DIMENSION AT MAXIMUM MATERIAL CONDITION.

DIM	MILLIMETERS		INCHES	
	MIN	MAX	MIN	MAX
A	9.80	10.00	0.386	0.393
B	3.80	4.00	0.150	0.157
C	1.35	1.75	0.054	0.068
D	0.35	0.49	0.014	0.019
F	0.40	1.25	0.016	0.049
G	1.27 BSC		0.050 BSC	
J	0.19	0.25	0.008	0.009
K	0.10	0.25	0.004	0.009
M	0°	7°	0°	7°
P	5.80	6.20	0.229	0.244
R	0.25	0.50	0.010	0.019

TSSOP-16
DT SUFFIX
CASE 948F-01
ISSUE O

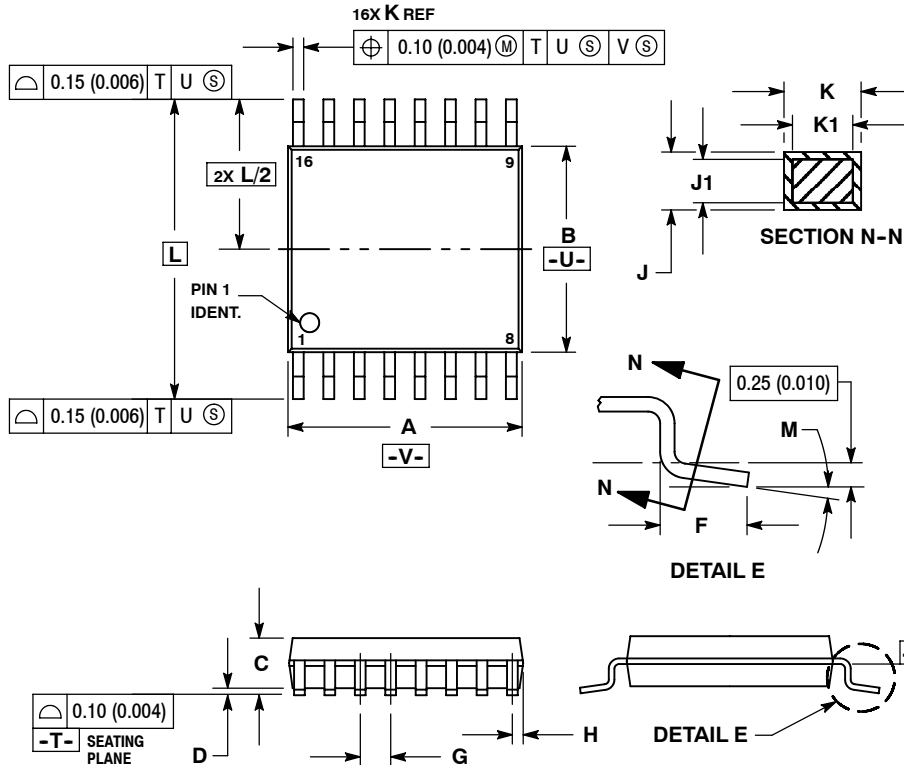

NOTES:

1. DIMENSIONING AND TOLERANCING PER ANSI Y14.5M, 1982.
2. CONTROLLING DIMENSION: MILLIMETER.
3. DIMENSION A DOES NOT INCLUDE MOLD FLASH, PROTRUSIONS OR GATE BURRS. MOLD FLASH OR GATE BURRS SHALL NOT EXCEED 0.15 (0.006) PER SIDE.
4. DIMENSION B DOES NOT INCLUDE INTERLEAD FLASH OR PROTRUSION. INTERLEAD FLASH OR PROTRUSION SHALL NOT EXCEED 0.25 (0.010) PER SIDE.
5. DIMENSION K DOES NOT INCLUDE DAMBAR PROTRUSION. ALLOWABLE DAMBAR PROTRUSION SHALL BE 0.08 (0.003) TOTAL IN EXCESS OF THE K DIMENSION AT MAXIMUM MATERIAL CONDITION.
6. TERMINAL NUMBERS ARE SHOWN FOR REFERENCE ONLY.
7. DIMENSIONS A AND B ARE TO BE DETERMINED AT DATUM PLANE -W-.

DIM	MILLIMETERS		INCHES	
	MIN	MAX	MIN	MAX
A	4.90	5.10	0.193	0.200
B	4.30	4.50	0.169	0.177
C	---	1.20	---	0.047
D	0.05	0.15	0.002	0.006
F	0.50	0.75	0.020	0.030
G	0.65 BSC		0.026 BSC	
H	0.18	0.28	0.007	0.011
J	0.09	0.20	0.004	0.008
J1	0.09	0.16	0.004	0.006
K	0.19	0.30	0.007	0.012
K1	0.19	0.25	0.007	0.010
L	6.40 BSC		0.252 BSC	
M	0°	8°	0°	8°

MC74VHC259

PACKAGE DIMENSIONS

SOIC EIAJ-16
M SUFFIX
CASE 966-01
ISSUE O

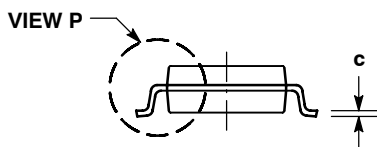
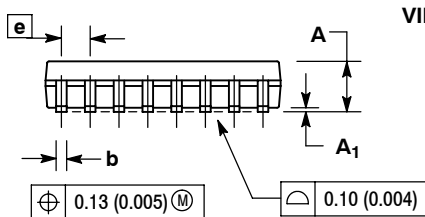
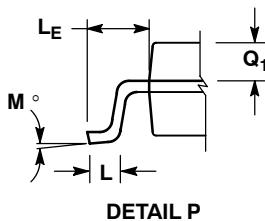
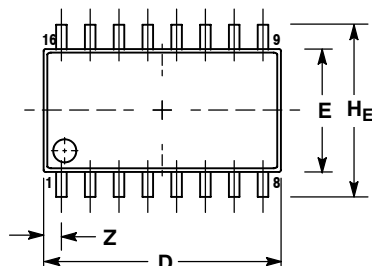

NOTES:

1. DIMENSIONING AND TOLERANCING PER ANSI Y14.5M, 1982.
2. CONTROLLING DIMENSION: MILLIMETER.
3. DIMENSIONS D AND E DO NOT INCLUDE MOLD FLASH OR PROTRUSIONS AND ARE MEASURED AT THE PARTING LINE. MOLD FLASH OR PROTRUSIONS SHALL NOT EXCEED 0.15 (0.006) PER SIDE.
4. TERMINAL NUMBERS ARE SHOWN FOR REFERENCE ONLY.
5. THE LEAD WIDTH DIMENSION (b) DOES NOT INCLUDE DAMBAR PROTRUSION. ALLOWABLE DAMBAR PROTRUSION SHALL BE 0.08 (0.003) TOTAL IN EXCESS OF THE LEAD WIDTH DIMENSION AT MAXIMUM MATERIAL CONDITION. DAMBAR CANNOT BE LOCATED ON THE LOWER RADIUS OR THE FOOT. MINIMUM SPACE BETWEEN PROTRUSIONS AND ADJACENT LEAD TO BE 0.46 (0.018).

DIM	MILLIMETERS		INCHES	
	MIN	MAX	MIN	MAX
A	---	2.05	---	0.081
A ₁	0.05	0.20	0.002	0.008
b	0.35	0.50	0.014	0.020
c	0.18	0.27	0.007	0.011
D	9.90	10.50	0.390	0.413
E	5.10	5.45	0.201	0.215
e	1.27 BSC		0.050 BSC	
H _E	7.40	8.20	0.291	0.323
L	0.50	0.85	0.020	0.033
L _E	1.10	1.50	0.043	0.059
M	0° 10°		0° 10°	
Q ₁	0.70	0.90	0.028	0.035
Z	---	0.78	---	0.031

ON Semiconductor and **ON** are registered trademarks of Semiconductor Components Industries, LLC (SCILLC). SCILLC reserves the right to make changes without further notice to any products herein. SCILLC makes no warranty, representation or guarantee regarding the suitability of its products for any particular purpose, nor does SCILLC assume any liability arising out of the application or use of any product or circuit, and specifically disclaims any and all liability, including without limitation special, consequential or incidental damages. "Typical" parameters which may be provided in SCILLC data sheets and/or specifications can and do vary in different applications and actual performance may vary over time. All operating parameters, including "Typicals" must be validated for each customer application by customer's technical experts. SCILLC does not convey any license under its patent rights nor the rights of others. SCILLC products are not designed, intended, or authorized for use as components in systems intended for surgical implant into the body, or other applications intended to support or sustain life, or for any other application in which the failure of the SCILLC product could create a situation where personal injury or death may occur. Should Buyer purchase or use SCILLC products for any such unintended or unauthorized application, Buyer shall indemnify and hold SCILLC and its officers, employees, subsidiaries, affiliates, and distributors harmless against all claims, costs, damages, and expenses, and reasonable attorney fees arising out of, directly or indirectly, any claim of personal injury or death associated with such unintended or unauthorized use, even if such claim alleges that SCILLC was negligent regarding the design or manufacture of the part. SCILLC is an Equal Opportunity/Affirmative Action Employer. This literature is subject to all applicable copyright laws and is not for resale in any manner.

PUBLICATION ORDERING INFORMATION

LITERATURE FULFILLMENT:

Literature Distribution Center for ON Semiconductor
P.O. Box 61312, Phoenix, Arizona 85082-1312 USA
Phone: 480-829-7710 or 800-344-3860 Toll Free USA/Canada
Fax: 480-829-7709 or 800-344-3867 Toll Free USA/Canada
Email: orderlit@onsemi.com

N. American Technical Support: 800-282-9855 Toll Free USA/Canada

Japan: ON Semiconductor, Japan Customer Focus Center
2-9-1 Kamimeguro, Meguro-ku, Tokyo, Japan 153-0051
Phone: 81-3-5773-3850

ON Semiconductor Website: <http://onsemi.com>

Order Literature: <http://www.onsemi.com/litorder>

For additional information, please contact your local Sales Representative.